

SPECIFICATIONS

Item		Parameter	
Rated power supply		AC110V ~ 50/60Hz	
Maximum power consumption		1600 W	
Type of water heater		Instantaneous	
Power cord length		1.5 m (4.92ft)	
Water proof level		IPX4	
Cleansing	Spray volume	Rear cleansing	Approx. 0.5 - 0.9 L/min (Approx. 0.13 - 0.24 gal/min)
		Front cleansing	Approx. 0.5 - 0.9 L/min (Approx. 0.13 - 0.24 gal/min)
		User setting cleaning	Approx. 0.5 - 0.9 L/min (Approx. 0.13 - 0.24 gal/min)
	Water temperature		Adjustable temperature: 32°C to 40°C (89°F to 104°F)
	Heater capacity		1400 W
	Safety device		Temperature fuse, water temperature sensor
	Backflow prevention device		Water level sensor
Warm air dryer	Warm air temperature ²		Adjustable temperature range: room temperature to 60°C about 40°C to 60°C (about 104°F to 140°F)
	Airflow speed		Approx. 4.8m/s (Approx. 15.75 ft/min)
	Heater capacity		200 W
	Safety device		Temperature fuse
Heated seat	Surface temperature		Adjustable temperature: from 32°C to 40°C (about 89°F to 104°F) <In auto energy saver: About 25°C (About 77°F)>
	Heater capacity		40 W
	Safety device		Temperature fuse
Water supply pressure		Minimum required water pressure: 0.1 MPa (14.50 PSI) <dynamic>, Maximum required water pressure: 0.75 MPa (108.75 PSI) <static>	
Water supply temperature		2 to 40°C (35.6 to 95°F)	
Working ambient temperature		2 to 40°C (35.6 to 104°F)	
Dimensions		683mm × 393mm × 495mm 26 4/5" × 15 1/2" × 19 1/2"	
Weight		Net: 32 kg (71 lb.) Gross: 40 kg (89 lbs)	

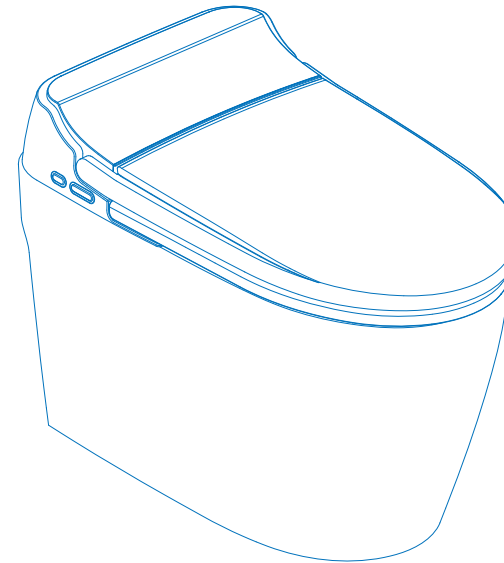

**PRODUCTS
INSTRUCTIONS**

Contents

SAFETY PRECAUTIONS	2
BEFORE INSTALLATION	8
Installation Space	8
Water pressure	8
Installation Drawing Plan	8
INSTALLATION	9
Floor drain gasket and bowl unit	9
Water supply	9
Seal the bowl unit	10
Connect power cord	10
Checklist and trial run	11
NAMES OF PARTS	12
WHAT'S IN THE BOX	13
FUNCTIONS OVERVIEW	13
SIDE BUTTON OPERATION	14
When user is sitting on the unit	14
When user is not sitting on the unit	14
REMOTE CONTROL OPERATION	15
MAINTENANCE	18
SPECIFICATIONS	19

SAFETY PRECAUTIONS

IMPORTANT





Read all instructions and warnings before using

Symbols and meanings

 **WARNING** May cause death or serious injury

 **CAUTION** May result in injury or property damage

The following symbols are used to indicate important safety instructions for the use of the product

Symbol	Meaning
	This symbol indicates a prohibited use of the product
	This symbol indicates a required step in the use of this product
	<ul style="list-style-type: none"> • This product is classified as Class 1 Equipment and must be grounded. • Install this equipment where a GFI (Ground Fault Circuit Interrupter) electrical outlet is accessible • This appliance is not intended for use by persons (including children) with reduced physical, sensory or mental capabilities, or lack of experience and knowledge unless they have been given supervision or instruction concerning use of the appliance by a person responsible for their safety • Children should be supervised to ensure that they do not play or tamper with the appliance
 WARNING	
	<p>Do not plug or unplug the power plug with wet hands. Doing so may cause electrical shock</p> <p>Do not get any water or cleaning solution on the top of unit or power plug Doing so may cause fire, electric shock, burns, or short circuiting Doing so may cause the product to crack resulting in injury or water damage</p> <p>Never disassemble, repair or alter the unit Doing so may cause fire, electric shock, burns, or short circuiting and may void product warranty</p> <p>Do not install the product on moving vehicles such as trailers or boats Doing so may cause fire, electric shock, burns, short circuiting or malfunction Moving parts of the unit may come loose and fall off, resulting in injury</p>

WARNING



Do not use the unit if a malfunction occurs.

Always unplug the power plug from the outlet.

Close the water shutoff valve to stop water supply

Possible malfunctions:

Water is leaking from a pipe or the tank

The product is cracked or broken

The product makes a strange noise or emits a strange odor

The product emits smoke

The product is abnormally hot

The bowl unit is clogged

The toilet seat is not in its original place.

Continued use after malfunction could cause a fire, electric shock, burn, short circuiting, injury or water damage

Only use tap water or potable well water/underground water. Do not use seawater

Doing so may cause irritation to the skin and malfunction

Do not touch the power plug during thunderstorms.

Doing so may cause fire or electric shock

Do not allow the water supply hose to touch the power plug or outlet.

Doing so may cause condensation resulting in a fire, electrical shock, burn or short circuiting.

Do not do anything that may damage the power cord, power plug.

Do not strike, yank, twist, excessively bend, damage, alter, or heat the power cords. Also, do not place anything heavy on, bind or pinch the power cords.

Using a damaged power cord may result in a fire, electrical shock, burn or short circuiting

Do not use a loose or faulty electrical outlet.

Doing so may cause fire or short circuit.

Do no use any outlet or wiring equipment beyond its specified rating.

Plugging too many plugs into the same outlet, for example using outlet splitters, can cause fire due to over-heating

Do not use any power supply other than the one specified. AC 120V, 60Hz.

Doing so may cause fire, malfunction or over-heating.

Do not stick a finger or anything else into the warm air outlet.

Do not place anything on the warm air outlet or drape clothes over it.

Doing so may cause burns, electrical shock or malfunction.

Keep cigarettes and other open flames away from the product.

Failure to do so may cause fire.

WARNING



Beware of irritation or burn

Improper use of the toilet seat may cause irritation or burn.

When sitting for a long time on the toilet seat, switch the toilet seat temperature adjustment to "OFF". When any of the following persons use a heated seat or warm air drying, someone should switch the toilet seat temperature adjustment to "OFF" and switch the drying air temperature to "Low".

Young children, the elderly, and other users unable to set the temperature appropriately themselves including; the ill, physically disabled and others who do not have freedom of movement; those using any medicines that cause drowsiness (sleeping or cold medicine), those who have been drinking heavily, anyone severely fatigued and anyone else liable to fall asleep are at risk.

This is an electrical product. Do not install it anywhere water is likely to get on the product or anywhere with humidity high enough that water is likely to form on the surface of this product.

When using the product in a bathroom, install a fan or ventilation port and ensure good air flow through the bathroom.

Failure to do so may cause fire or electrical shock.

Always connect the TitanDT-300 to the cold-water supply.

Connecting to hot water supply may result in burns and equipment damage.

Make sure that a properly grounded (3 prong) outlet has been installed.

Failure to install a grounded outlet could cause electrical shock in the event of a malfunction or short circuit.

Insert the power plug securely into the outlet.

Failure to do so may cause fire, over-heating, or short circuiting.

To unplug, hold the power plug, not the power cord.

Do not unplug by pulling the power cord. Pulling on the power cord may cause damage and result in fire or over-heating.

If the power cord is damaged, avoid danger by having the manufacturer's repair department or equivalent specialist replace it.

Always disconnect the power plug from the outlet before cleaning, maintenance or inspection.

Failure to do so may cause electrical shock or malfunction.

Except when using "Wand cleaning".

WARNING

Periodically remove dust and dirt from the power plug and make sure it is securely plugged into the wall outlet.

Failure to do so may cause fire, over-heating or short circuiting
Pull the plug out from the outlet and wipe clean with a dry cloth.

Always unplug the power plug from the outlet before removing the top unit.

Failure to do so may cause fire or electrical shock.

Preliminary studies in females suggest that overuse of continuous spraying can increase the possibility of vaginal mucosa drying and potential reduction in desirable microbial organisms.

Although these studies have not been validated, please consult your healthcare provider for concerns regarding whether these circumstances may apply to you.

More importantly, if you are an individual suffering from any immune deficiency as a result of disease, chemotherapy, or other medical condition compromising the immune system you should consult your healthcare provider before use of this product.

CAUTION



Do not use the product if the top unit is unstable.

• Doing so may cause the top unit to come loose and fall, resulting in injury.

If the product is damaged, do not touch the damaged section.

• Doing so may cause electrical shock or injury. Replace it immediately.

Do not apply strong force, mechanical shock, step on or stand on the toilet seat, toilet lid or top unit. Also do not place any heavy object on the toilet seat, toilet lid or top unit.

• Doing so may cause cracking or cause the top unit to come loose and fall, resulting in injury.
• Doing so may damage the product and cause injury or water damage.

Do not lift up this product by the toilet seat or lid.

Do not raise the toilet seat or lid while objects are resting on top of the toilet.

• Doing so may cause the top unit to come loose and fall, resulting in injury.

When cleaning or maintaining the plastic parts (top unit etc.) or the water supply hose, use a kitchen cleaner diluted with water. Do not use any of the following.

Toilet cleaner, household cleaner, benzene, paint thinner, powdered cleanser or nylon scrubbing pads.

• These items may damage or crack the plastic and cause injury or malfunction.
• These items could damage the water supply hose and cause a water leak.

To prevent a sudden water leak, do not remove the water filter drain valve when the shutoff valve is open.

• Doing so will cause water to spurt out.

(Refer to Page 34 for instructions on cleaning the water filter drain valve.)

Do not fold or crush the water supply hose; do not damage by cutting with a sharp object.

Doing so may cause water leaks.

Do not pour hot water into the toilet.

• Doing so may result in damage to the toilet, injury or water damage.

Do not flush anything other than bodily waste and toilet paper. Also, do not flush too much toilet paper.

• Doing so may clog the toilet, causing waste water overflow and water damage.



If a water leak should occur, always close the shutoff valve.

When the ambient temperature is likely to drop to 0°C (32°F) or lower, prevent damage to the pipes and hoses due to freezing.

- Frozen water pipes could cause the top unit and the pipes to break, resulting in a water leak.
- Regulate the room temperature to prevent the pipes and hoses from freezing during cold months.

When not using the unit over an extended period of time, drain the water out of the top unit and the water supply hose after closing the water shutoff valve, and pull the power plug from the outlet.

When using the product again, allow the product to refill with water first.

- Otherwise, the water in the tank might become contaminated and cause skin inflammation or other problems.
- Leaving the power on may cause fire or over-heating.

When installing the water filter drain valve, make sure that it is securely tightened in its proper position.

- Failure to securely tighten it may cause a water leak.

If the bowl unit is clogged, disconnect the power plug and remove the clog.

- If the auto flush is functioning, it could make the wastewater in the bowl unit overflow and may result in water damage.
- Use commercially available tools that are made for unclogging the bowl unit to remove the clogging.

Always flush, even after just urinating.

- Failure to do so may cause inadequate flushing or clogging of the bowl unit, resulting in waste water overflow and water damage.

Wipe condensation on the bowl unit, tank, water supply pipe and shutoff valve with a dry cloth.

- Condensation may cause staining and corrosion of the floor.
- Ventilate the restroom to prevent condensation.

Wipe any urine, condensation, cleaner, water, etc. that has gotten on the floor with a well-wrung mop or cloth.

Failure to do so may cause staining and corrosion of the floor.

⚠ DANGER To reduce the risk of electrocution

1. Do not use while bathing.
2. Do not place or store the product where it can fall or be pulled into a tub or sink.
3. Do not place in or drop into water or other liquid.
4. Do not reach for the product when it has fallen into water. Unplug it immediately.

BEFORE INSTALLATION

INSTALLATION SPACE

- Ensure there is enough space around the unit, confirm the bathroom door or shower door will not hit the unit when they open.
- Ensure the minimum distance from the wall to the center of the floor drain is 300mm or 12" long.
- A GFI plug is required close to the unit.

WATER PRESSURE

- Minimum required water pressure: 0.1MPa (1.0kgf/cm²) (flow of water is greater or equal to 20L or 5.3 gallon per minute)
- Unit may not function well if water pressure fails to reach this level
- Check the water pressure: open the valve and let the water run into a bucket with volume measure for 15 seconds, if water in the bucket is more than 4L, minimum water pressure is met.

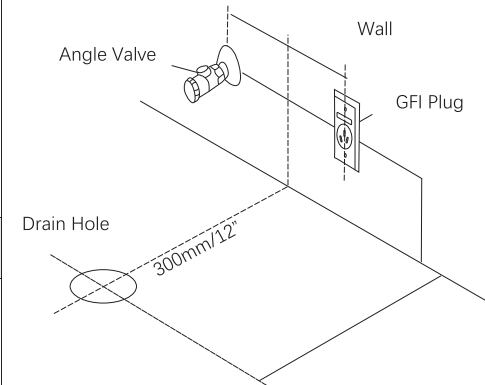

INSTALLATION DRAWING PLAN

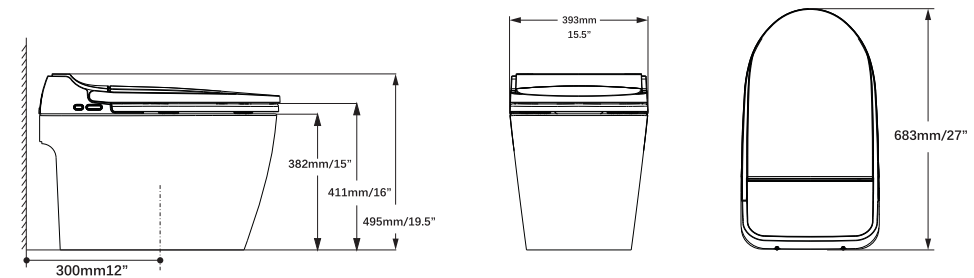

⚠ CAUTION

- The drawing plan is not the actual scale of the unit.
- When doing the installation in cold weather, leave the unit in room temperature for at least two hours before installing.

INSTALLATION

FLOOR DRAIN GASKET AND BOWL UNIT

1. Install gasket on floor drain and seal well. (see figure 1)
2. Carefully install bowl unit on socket. (see figure 2)

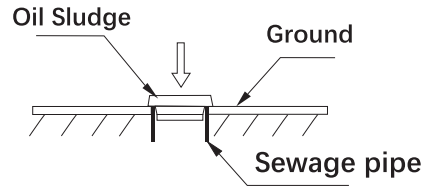

Figure 1

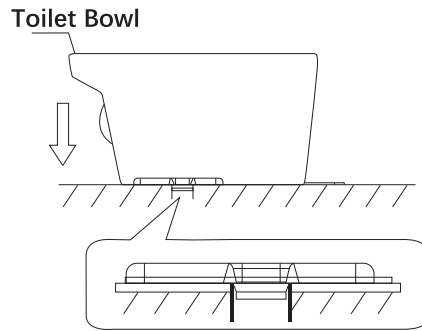

Figure 2

WATER SUPPLY

1. Turn off water valve on the wall
2. Attach given with angle valve
3. Turn on the valve for a minute to keep inside of valve clean
4. Turn off the valve, connect the valve and the unit with pipe, turn on the valve again, carefully check for leakage

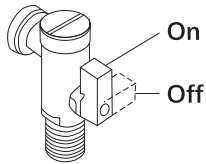

Figure 3

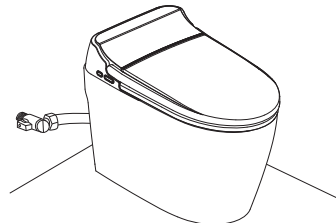

Figure 4

Filter screen should be cleaned with clear water every three months
Steps to clean filter screen: Turn off the valve, unscrew filter screen, carefully rinse with clean water.

Pipe and valve could be different from above graphic, due to production batches, please refer to actual product

SEAL THE BOWL UNIT

Seal the gap between bowl unit and the ground, to further prevent water and odor leakage. Evenly apply a layer of general-purpose sealant (not included with the unit) around bottom of bowl unit, smooth the sealant with finger. Allow the sealant to dry for at least 24 hours. (Follow instructions of specific sealant you use)

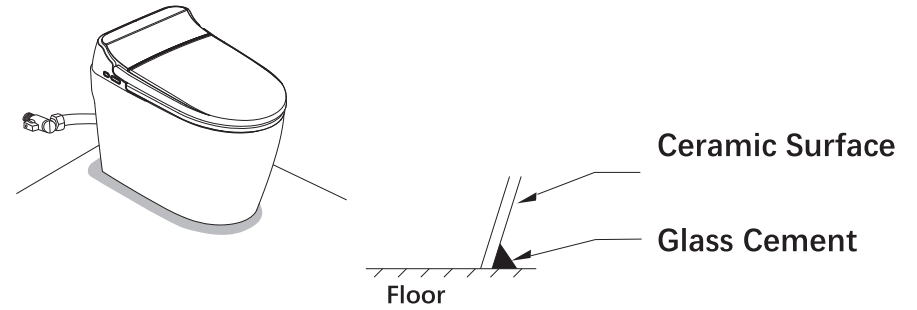
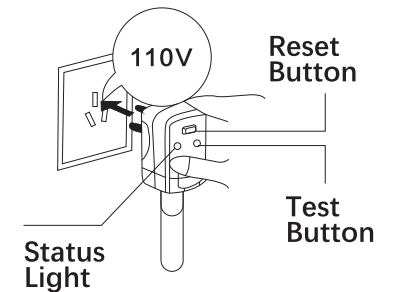

Figure 5

CONNECT POWER CORD

1. Power cord must be connected to a 110V, 60Hz, 16A+, grounded GFI (Ground Fault Circuit Interrupter) power source.
2. After power cord connect power source, make sure the pilot lamp is light up; if pilot lamp become too dark, please press the reset button.
3. Wait for the unit finish self-inspection after the pilot lamp lighted up. It is normal that user see side button flash blue light, wand stretch out, machine engage on and flash sound.
4. Self-inspection is done when pilot lamp stops flushing.



CHECKLIST AND TRIAL RUN

- Power plug is securely connected to a grounded AC110V, 16A, 60Hz GFI power source
- Water valve is turned on
- All connection points are securely fastened
- No water leakage
- Power indicator on the unit is on
- Perform all functions with remote control and side buttons (place one hand on the sensor area on the seat to activate certain functions, place a plastic sheet between the seat and toilet bowl to avoid water spraying out of the bowl)
 - Front and rear wash
 - Massage
 - Water temperature
 - Spray strength
 - Nozzle position
 - Nozzle self-cleansing
 - Air dryer
 - Air temperature
 - Seat temperature
 - Flushing

A trial run is mandatory for safety purposes, if any malfunction has occurred, return the product to your distributor for a replacement or a refund.

NAMES OF PARTS

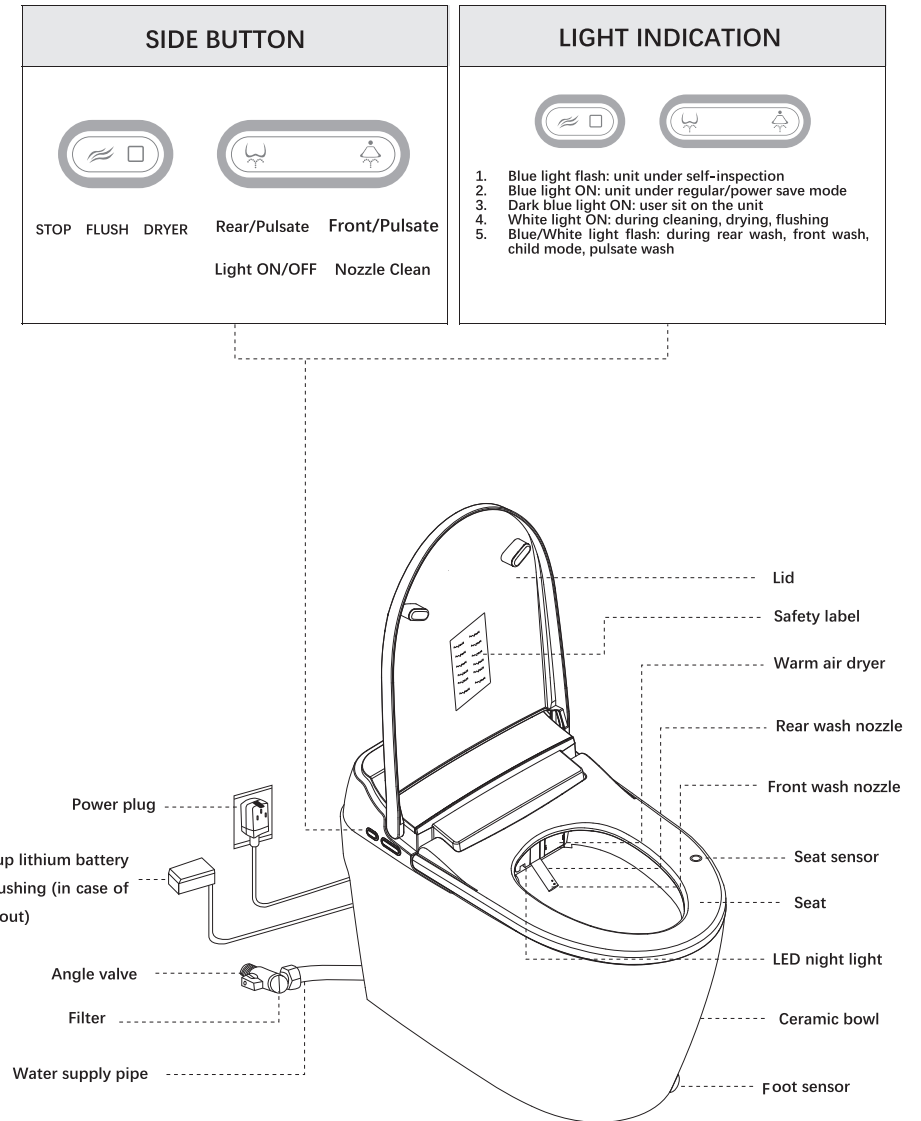

There could be minor difference between actual product and above graphic, due to production batches.

WHAT'S IN THE BOX





Main unit	1	Remote control (battery included)	1
Angle valve (Filter screen inside)	1	Seal socket	1
Connection pipe	1	Power back up battery	1
Printing materials:		User manual, Warranty card, Certificate of approval	

FUNCTIONS OVERVIEW

FEATURED FUNCTIONS:

HYGIENE	SAFETY	COMFORT
Rear wash Front wash Stainless steel nozzle Self-cleansing nozzle Moist bowl unit before use	Over heat protection Low temperature burn protection Silent closing seat and cover Fire retardant seat Pressure resistance seat Power saving mode Leak protection IPX 4 water proof Power-outage flush Power-outage memory	Warm air drying Heated seat Adjustable water temperature Adjustable water pressure Adjustable air temperature Adjustable nozzle position Night light Remote/foot sensor flush Auto flush

SIDE BUTTON OPERATION

WHEN USER IS SITTING ON THE UNIT	
	Press once to start rear cleansing, regular cleansing time is 90 seconds, press again within 90 seconds to activate pulsate cleansing, again to stop pulsate cleansing. When rear cleansing finish, unit will start warm air-drying for 240 seconds by default.
	Press once to start front cleansing, regular cleansing time is 90 seconds, press again with 90 seconds to activate pulsate cleansing, again to stop pulsate cleansing. When front cleansing finish, unit will start warm air-drying for 240 seconds by default.
	When user is seated on the unit, press once to start warm air-drying for 240 seconds. When other functions are in process, press once to stop function. When the unit connected to power supply, press and hold button to begin manual flushing. Note: if the unit is not connected power supply, press and hold button to begin manual flushing by Lithium battery. (Lithium battery life is approximately 600 uses. If user needs to change the battery, please contact technician support for more help).
Foot sensor	Tap the foot sensor to activate flushing.
WHEN USER IS NOT SITTING ON THE UNIT	
	Press once to turn ON/OFF color light which show on the side button
	Press once to stretch wand out, the nozzle starts self-cleaning for 90 seconds.



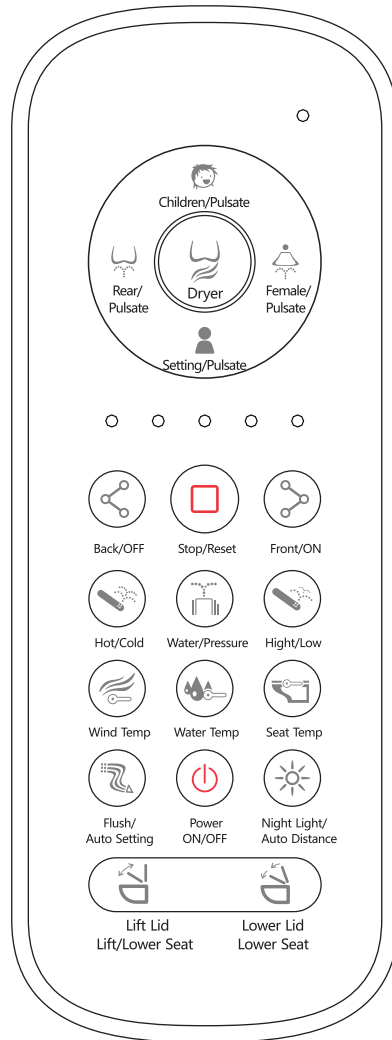







REMOTE CONTROL OPERATION











Note:

Remote control could be different from above graphic, due to production batches, please refer to actual product.

BUTTONS AND FUNCTIONS

 Children/Pulsate	<p>Press once to start child cleansing, regular cleansing time is 90 seconds and warm air-drying is 240 seconds. Press again to activate pulsate cleansing, again to stop pulsate cleansing.</p> <p>Child function: water temperature is level 3, wand is level 5, water pressure is level 2, dryer temperature is level 2 by default.</p> <p>Note: when child function is on, all the function will be disabled until child cleansing is finished. (Except child clean button and stop button).</p>
 Rear/Pulsate	<p>Works when user is sitting on the unit.</p> <p>Press once to start rear cleansing, regular cleansing time is 90 seconds and warm air-drying is 240 seconds, press again within 90 seconds to activate pulsate cleansing, again to stop pulsate cleansing.</p> <p>After adjusting user preferences, press and hold setting button for 4 seconds, when top light indicator and the fifth function light indicator starts to flash, rear cleansing preference has been set.</p>
 Dryer	<p>Works when user is sitting on the unit.</p> <p>Press once to initiate warm air drying, regular drying time is 240 seconds, corresponding light indicator will display current temperature setting. Press wind temp button to switch between temperature settings.</p>
 Female/Pulsate	<p>Works when user is sitting on the unit.</p> <p>Press once to start front cleansing, regular cleansing time is 90 seconds and warm air-drying is 240 seconds, press again within 90 seconds to activate pulsate cleansing, again to stop pulsate cleansing.</p> <p>After adjusting user preferences, press and hold setting button for 4 seconds, when top light indicator and the fifth function light indicator starts to flash, female cleansing preference has been set.</p>
 Setting/Pulsate	<p>Press once to start user setting function which regular cleansing time is 90 seconds and warm air-drying is 240 seconds. (water temperature, wand level, water pressure and dryer temperature will process by user's setting). press again within 90 seconds to activate pulsate cleansing, again to stop pulsate cleansing.</p>
 Back/OFF  Front/ON	<p>Press Back button and Front button to control wand level. 1 light on is minimum and 5 light on is maximum.</p> <p>When user switch to setting mode, Back button is turn on and Front button is turn off.</p>
 Stop/Reset	<p>Press once to stop function which is running and switch to standby mode. Press and hold button for 4 seconds, all the light indicator will light up for 3 seconds then all the function will be reset.</p>
 Hot/Cold	<p>Press once to turn on hot and cold massage function. Press again to turn off.</p> <p>Hot and cold massage function: the massage which water temperature will be alternate heating and cooling in one work period.</p>
 Water/Pressure	<p>Press to switch between water pressure settings.</p> <p>○○○○○: 0 light on - no water pressure activates.</p> <p>●●●●●: 5 light on - 0.9 L/min or 0.24 gal/min</p>

 High/Low	Press once to turn on high and low massage function. Press again to turn off. High and low massage function: the massage which the water pressure will be alternate high and low in one work period.
 Wind Temp	Press to switch between warm air-drying temperature levels. ○○○○: 0 light on - wind temperature is at room temperature ●○○○: 1 light on - approximately 40°C or 104°F ●●○○: 2 light on - approximately 45°C or 113°F ●●●○: 3 light on - approximately 50°C or 122°F ●●●●: 4 light on - approximately 55°C or 131°F ●●●●: 5 light on - approximately 60°C or 140°F
 Water Temp	Press to switch between water temperature levels. ○○○○: 0 light on - water temperature is at room temperature ●○○○: 1 light on - approximately 32°C or 89°F ●●○○: 2 light on - approximately 34°C or 93°F ●●●○: 3 light on - approximately 36°C or 96°F ●●●●: 4 light on - approximately 38°C or 100°F ●●●●: 5 light on - approximately 40°C or 104°F
 Seat Temp	Press to switch between seat temperature levels. ○○○○: 0 light on - seat temperature is at room temperature ●○○○: 1 light on - approximately 32°C or 89°F ●●○○: 2 light on - approximately 34°C or 93°F ●●●○: 3 light on - approximately 36°C or 96°F ●●●●: 4 light on - approximately 38°C or 100°F ●●●●: 5 light on - approximately 40°C or 104°F
 Flush/ Auto Setting	Press once to initiate flush. Press and hold the button for 2 seconds to switch automatic flush settings. 1. ○●●●: To set eco-flush mode, press "<" to turn OFF and press ">" to turn ON. 2. ●●●●: press once to set automatic flush setting, press "<" to turn OFF and press ">" to turn ON. 3. ●●●●: press twice to set flush setting, press "<" to set up flush after user leave seat and press ">" to set up flush before warm air-drying function turns on. 4. Press stop button or wait for 18 second to exit setting mode. Note: press and hold stop button for 4 seconds to reset all settings to factory default.
 Power ON/OFF	Press once to turn ON the unit. Press and hold the button for 2 seconds to turn off the unit.
 Night Light/ Auto Distance	Press once to turn ON night light function, press again to switch between night light settings. (white - dark blue - light blue - OFF).
 Lift Lid Lift/Lower Seat	Press once to lift lid, press again to lift/lower seat.
 Lower Lid Lower Seat	Press once to lower seat. press again to close lid.

MAINTENANCE

REGULAR MAINTENANCE

Cleaning the unit

- Gently wipe dirt and stains with a dry soft cloth or sponge, do not apply any chemical solutions to the unit.

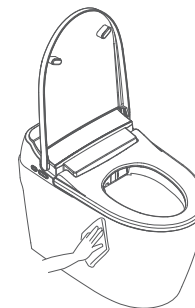

Cleaning the nozzle

- Works when user not sitting on the unit.
Press female clean button by side button, the wand will stretch out and self-cleaning function will initiate. When self-cleaning function turn on, the nozzle will not spray water. Gently wipe the nozzle with a soft cloth or brush with toothbrush.
- The cleansing schedule is 90 seconds, the wand will be static in first 70 second and will move back and forth in last 20 seconds. Wand will retract back to the unit after. Repeat the process if necessary.
- Warning, do not apply force by pulling, pushing or attempt to bend the nozzle, this will result in damage or electrical shock.

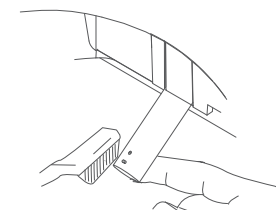

Cleaning the filter

- Power off the unit, unplug power cord with dry hand. Use tool to Unscrew the filter if necessary.
- Rinse with clear water, use a brush if necessary.
- Install the filter back to its original position, check for leakage.

