

INSTALLATION GUIDE

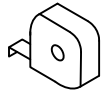

A

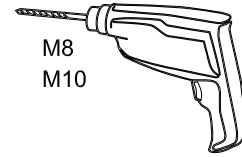
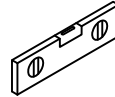
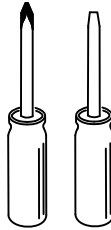
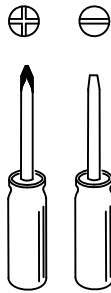
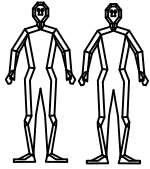
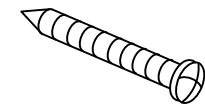

4pcs

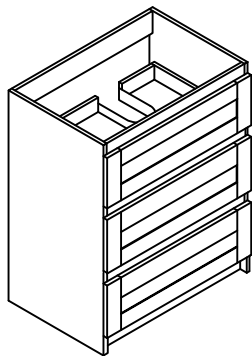
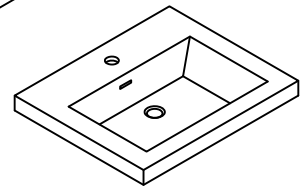
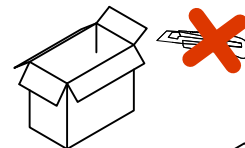
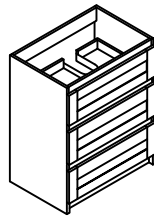
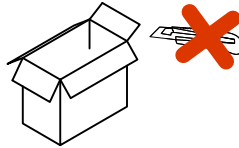

35.4"

DRAWER REMOVAL (if applicable)

1. REMOVE / RETIRAR

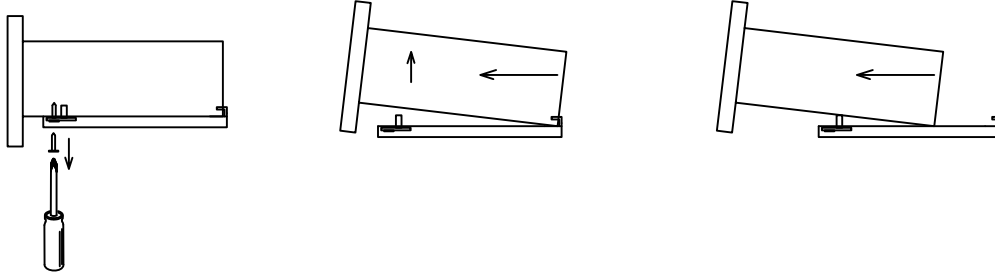

2. INSTALL / INSTALAR

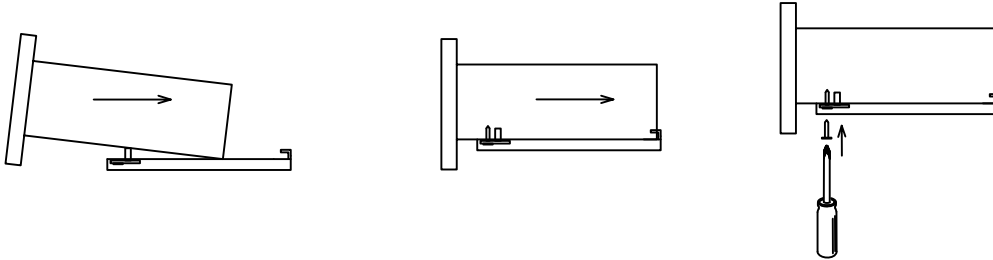

2. WALL CABINET INSTALLATION

STEP 1: SELECT HARDWARE THAT IS BEST SUITED FOR YOUR WALL TYPE

IMPORTANT: USE "PAN HEAD" OR "ROUND HEAD" SCREWS WITH SEAT WASHERS. SEAT SCREWS TIGHTLY AGAINST BACK RAIL OR PANEL WITHOUT DRIVING INTO BACK RAIL OR PANEL MATERIAL.

PASO 1: INSTALACION DE GABINETES, SELECCIONE LA HERRAJERIA QUE MAS SE ADECUA AL TIPO DE SU PARED.

IMPORTANTE: USA TORNILLOS DE "CABEZA PLANA BISELADA" O "CABEZA REDONDA" CON ARANDELAS DE ASENTO. COLOCA LOS TORNILLOS FIRMEMENTE CONTRA EL PANEL O EL RIEL TRASERO SIN INSERTARLOS EN EL PANEL O EL RIEL

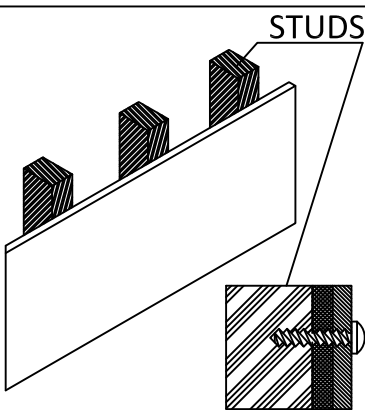

STUDS: Secure to wall with #10 x 3" screws at stud location. Locate at least 2 wall studs

MONTANTES: Fjelo a la pared con tornillos de # 10 x 3 pulgadas en los montantes.

Use at least 4 wall anchors when installing a 24" and 30" cabinet. Use at least 6 wall anchors when installing a 36" and 48" cabinet.

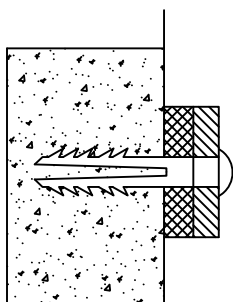

CONCRETE: Drill $\frac{1}{4}$ " holes, insert #10 wall anchors and secure to wall with #10 x 3" screws.

CONCRETO: Taladre orificios de $\frac{1}{4}$ pulgada, inserte anclas de expansión de #10 y fíjelo a la pared con tornillos de # 10 x 3 pulgadas.

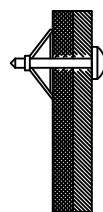

DRYWALL: Drill holes and secure to the wall with toggle bolts. Note: Use toggle bolts only when cabinet cannot be attached to a wall stud.

PANEL DE YESO: Taladre los orificios y fije la unidad a la pared con pernos acodillados.

Nota: Use pernos acodillados sólo cuando el gabinete no se pueda fijar a los montantes de pared.

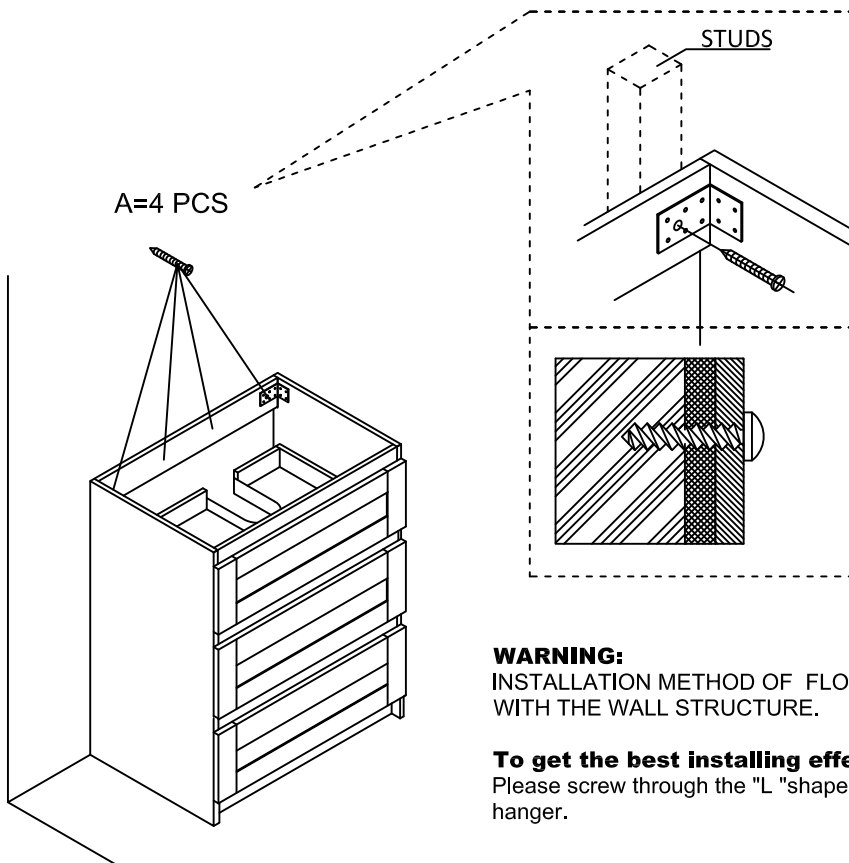

WARNING:
INSTALLATION METHOD OF FLOATING VANITY HAS BIG RELATION WITH THE WALL STRUCTURE.

To get the best installing effect, please follow as below:
Please screw through the "L" shape hanger if there is exactly wall stub behind the hanger.

1

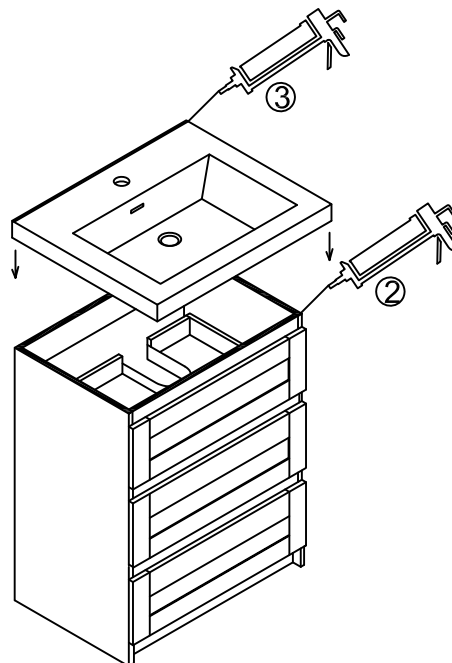
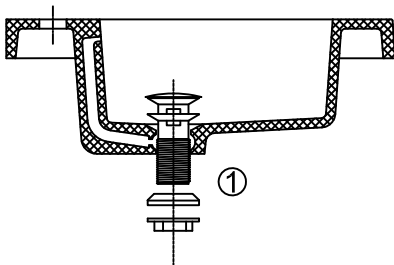

2