

# shower panel

MODEL : ID-101

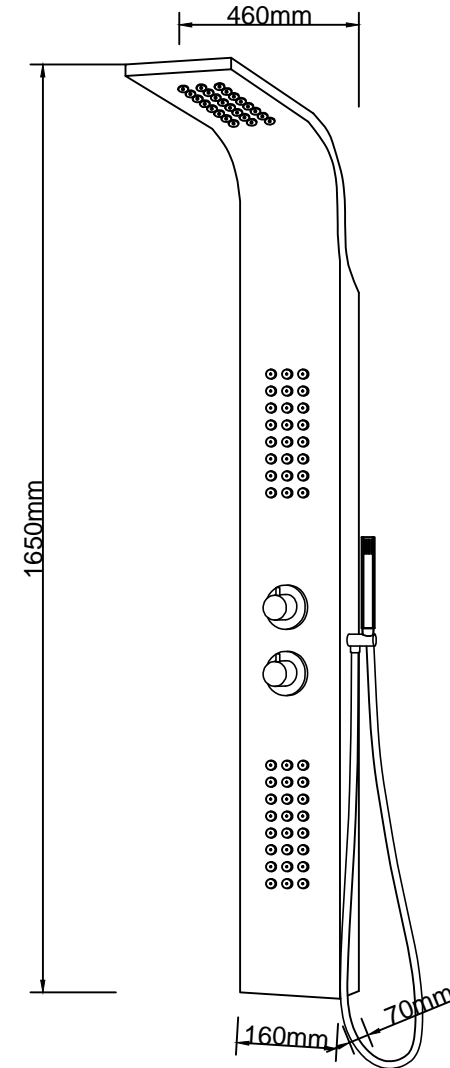

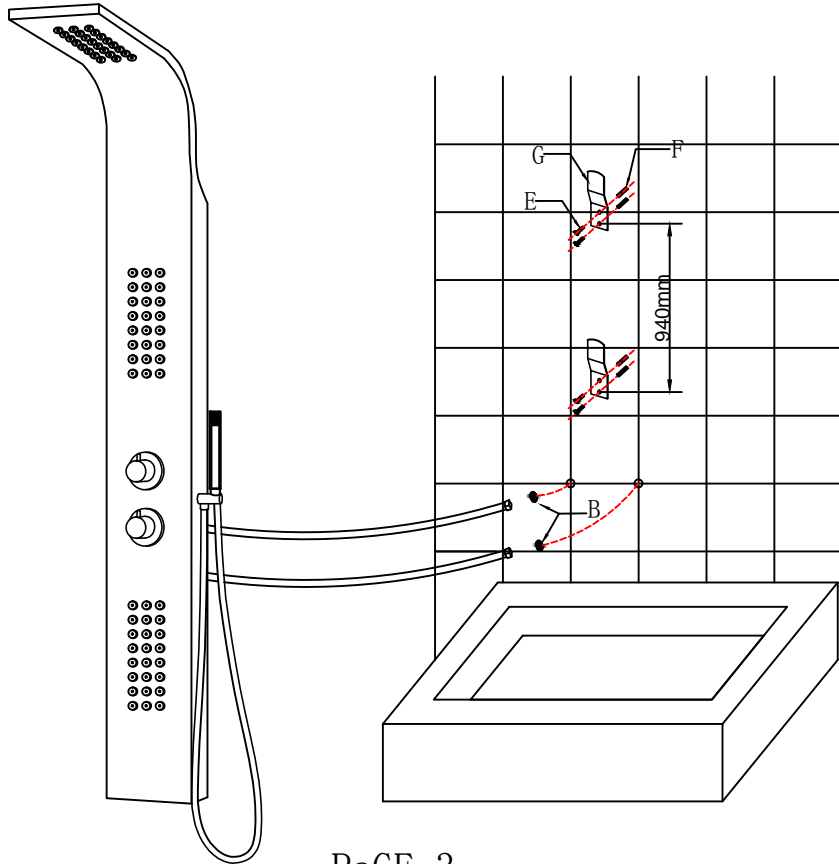



PaGE 1

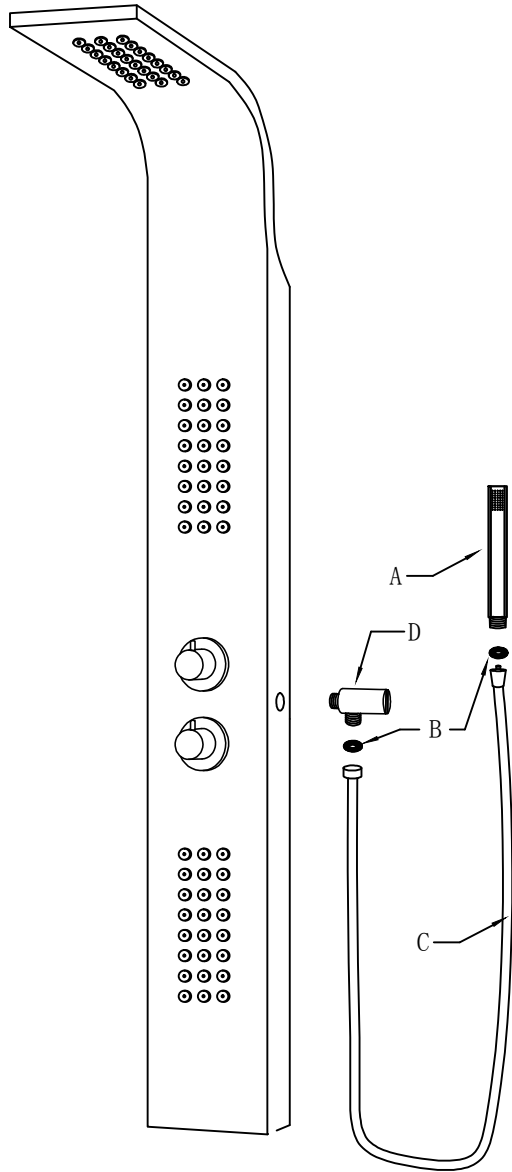

PaGE 3

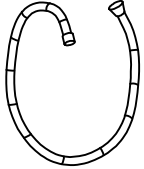
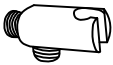
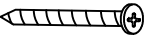

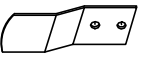
No.	Description	QTY
A		1
B		4
C		1
D		1
E		4
F		4
G		2